

## Magnets button

### Item description/product images



### Description

**Material:**  
Magnetic core AlNiCo.

**Version:**  
painted red.

**Note:**  
Split attractive surface with through hole. Non-shielded system. Button magnets are used in laboratories, inspection rooms and for holding metal objects.

**Temperature range:**  
max. 450°C.

**Drawing reference:**  
1) magnetic face

### Drawings

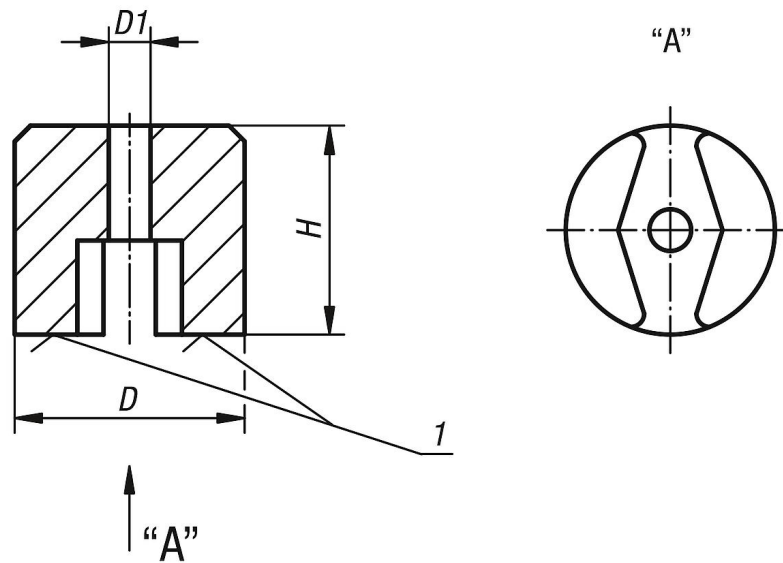

### Overview of items

#### Magnets button

Order No.	D	D1	H	Magnetic force N
K0559.01	13	4,2	10	7
K0559.02	19	5,4	13	19
K0559.03	25	5,4	16	29
K0559.04	32	7	25	66